

Omnibus STM32F4 F4 Pro V3 Flight Controller



Produktkode: 461aa

Tilgjengelighet: Opp til 1 mnd leveringstid

Custom Field 5 (Location): S125c

Pris: kr. 512,00

Short Description

Betaflight Omnibus STM32F4 F4 Pro V3 Flight Controller Built-in OSD

Beskrivelse

Features :

Following in the footsteps of the Omnibus F3 Pro, the Omnibus F4 Pro V3 may be the standard by which all other flight controllers are measured.

Boasting an F4 processor, on-board Betaflight OSD, MicroSD Black Box, 5v3a sbec, video filter, you'll be tuning pids with your transmitter and tearing it up at the track in no time!

With leaps and bounds in programming, it is now possible to connect your Smartaudio capable VTX such as the TBS Unify Pro 5G8 HV or TBS Unify Pro 5G8 HV - Race Edition to the J10 header using our Omnibus smartaudio connector and make VTX changes on the fly through the betaflight OSD.

Specification:

Item name: Omnibus F4 Pro V3 Flight Controller

Size: 36x36mm

Mount holes: 30.5x30.5mm

STM32 F405 MCU

Dshot support

Drag and Drop OSD configured via Betaflight Configurator

Smartaudio v2 support - Tune your PID's and configure the omnibus fc from your Transmitter

MPU6000 6 axis SPI Gyro & Accelerometer

SBUS/PPM AND Spektrum DSMX Ports

MicroSD card blackbox

Baro(BMP280)

5v3a SBEC

On-board Video Filter(only can supply 5V to VTX and Camera)

SmartAudio V2 via tx6 on J10

4×3 pin ESC pin layout

IR pins for lap timing transponder

Package included:

1* Omnibus F4 Pro V3 Flight Controller

Pinout

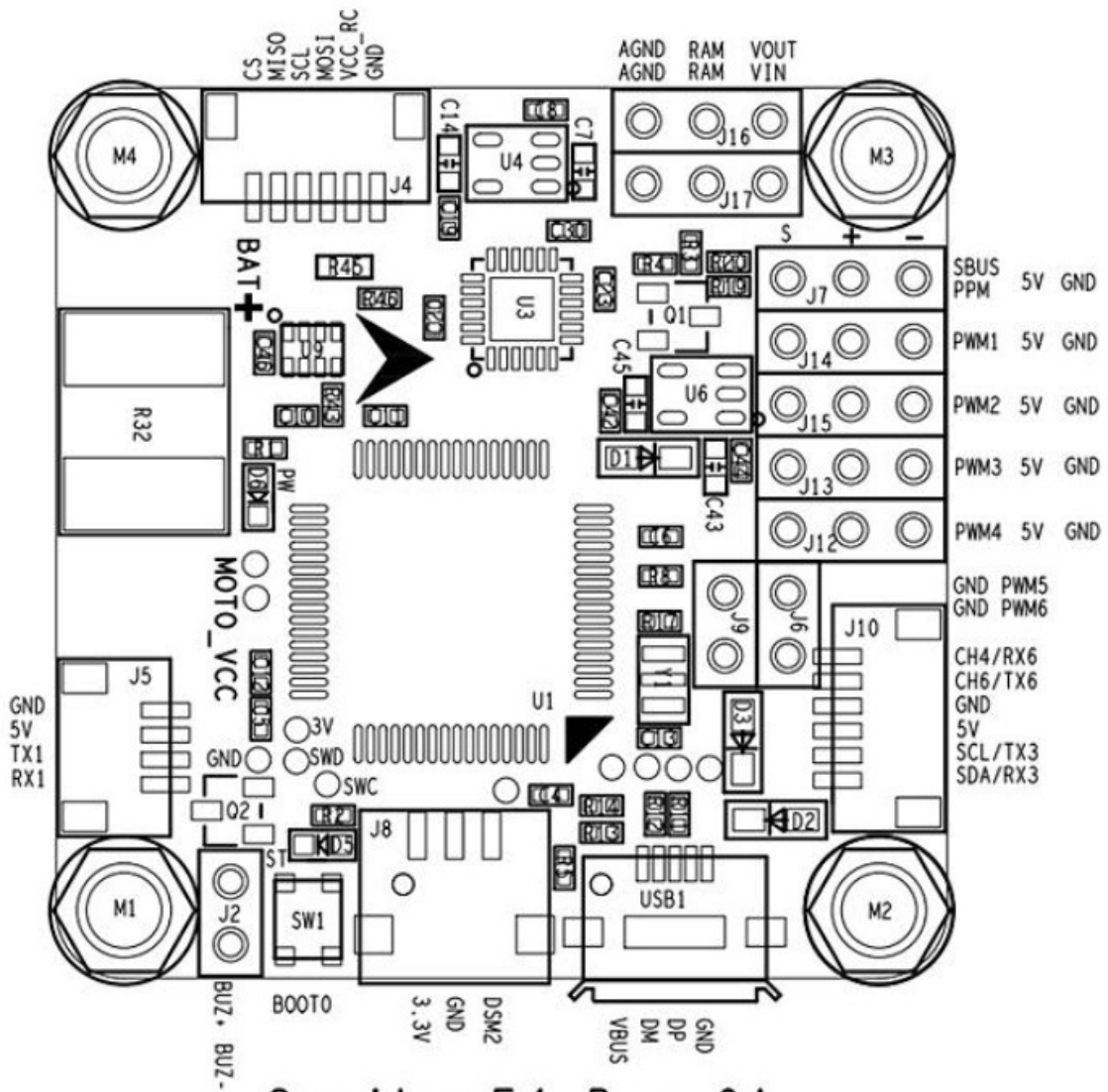

OmnibusF4-Pro-0A

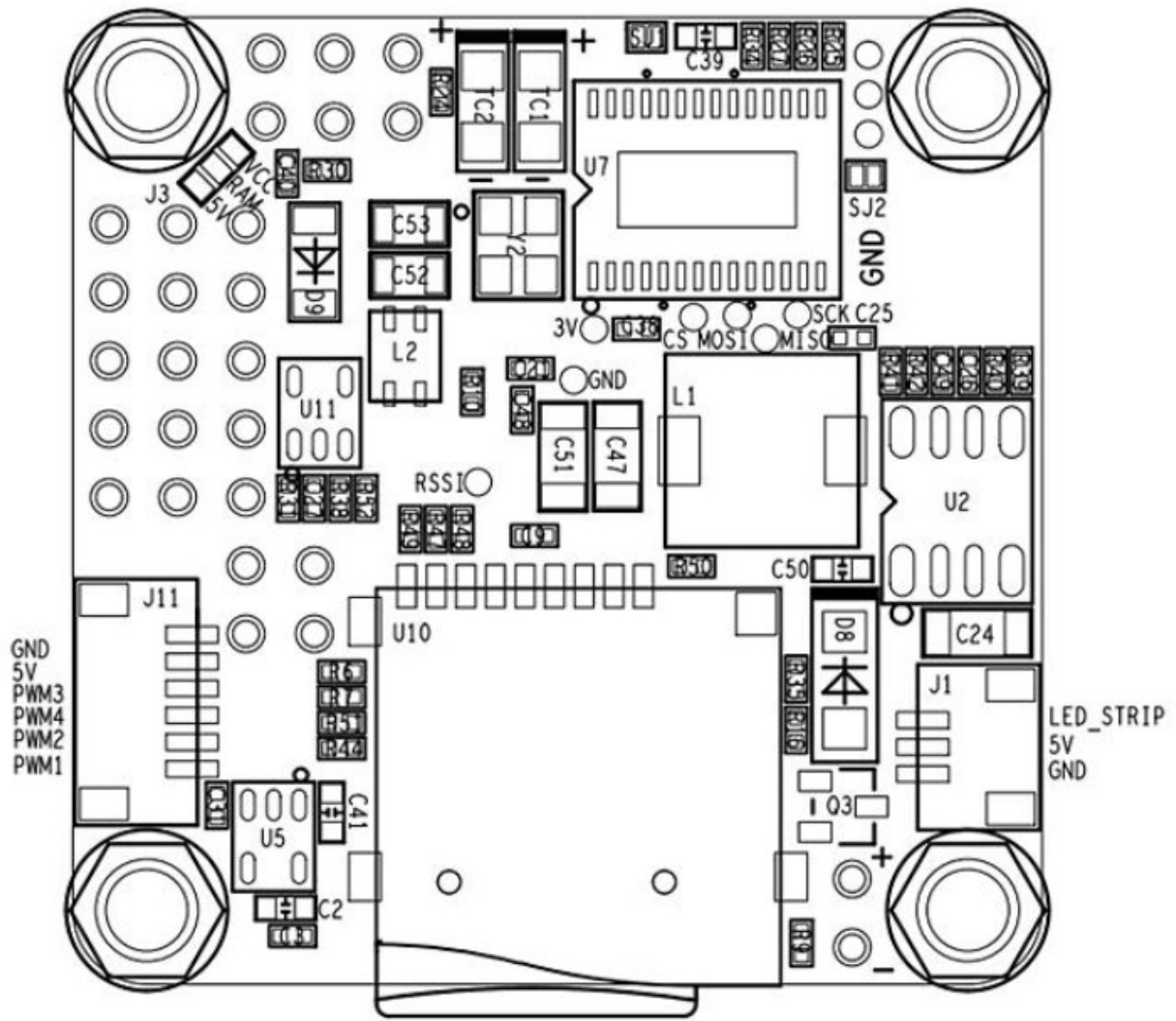

OmnibusF4-Pro-0A

OMNIBUS F4 PRO V3 - ARDUPILOT WIRING

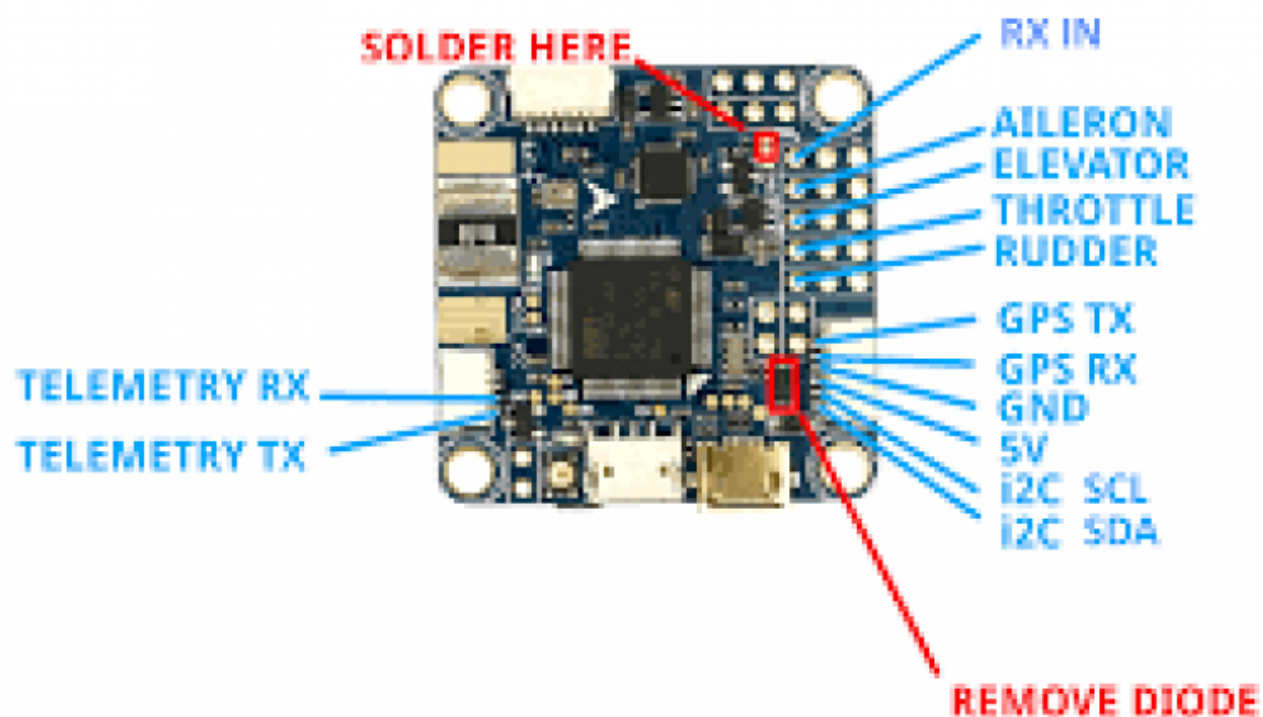

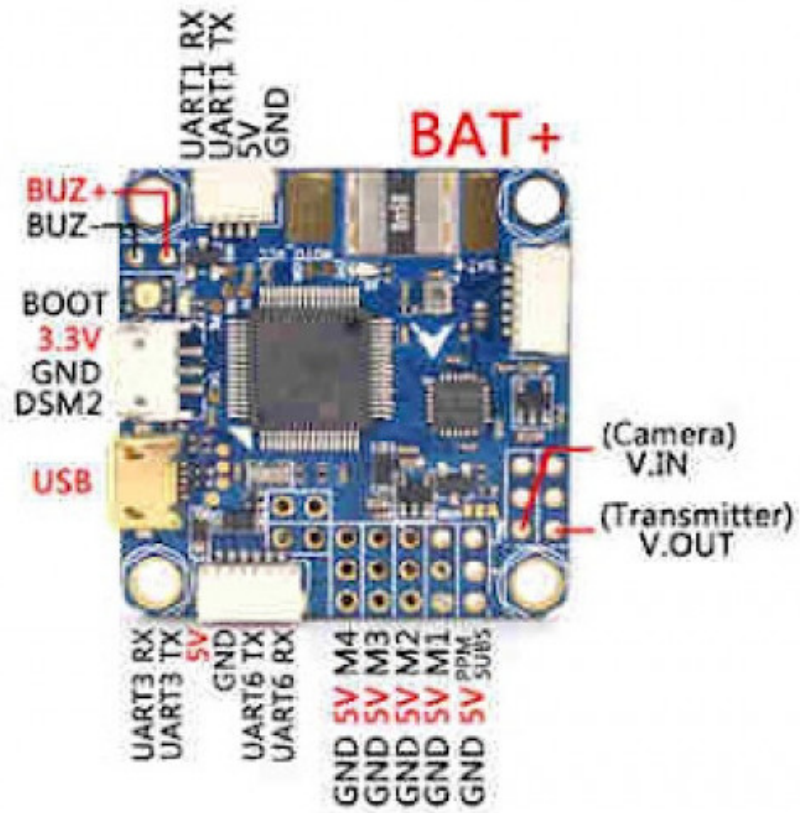

Omnibus F4 Pro Crossfire With Telemetry Unfiy Pro HV w/ SmartAudio

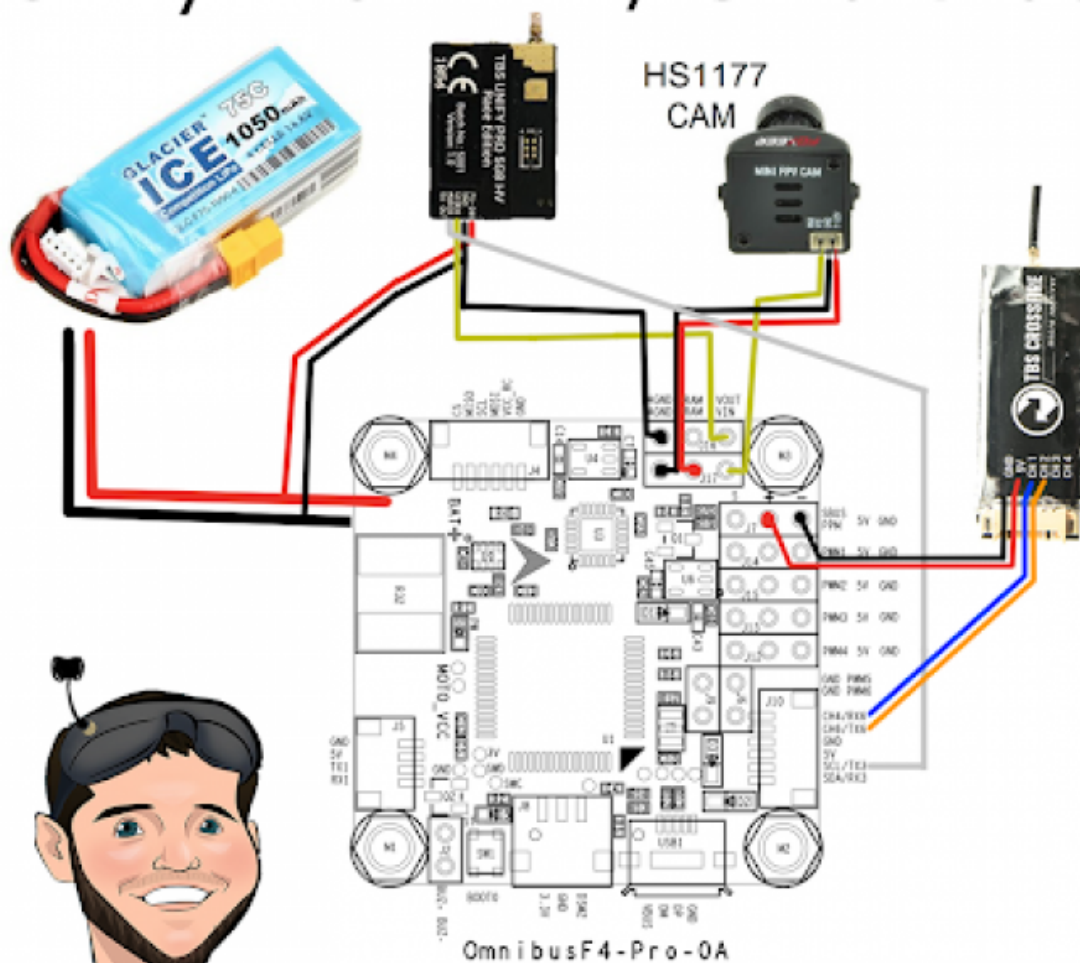

OmnibusF4 Pro

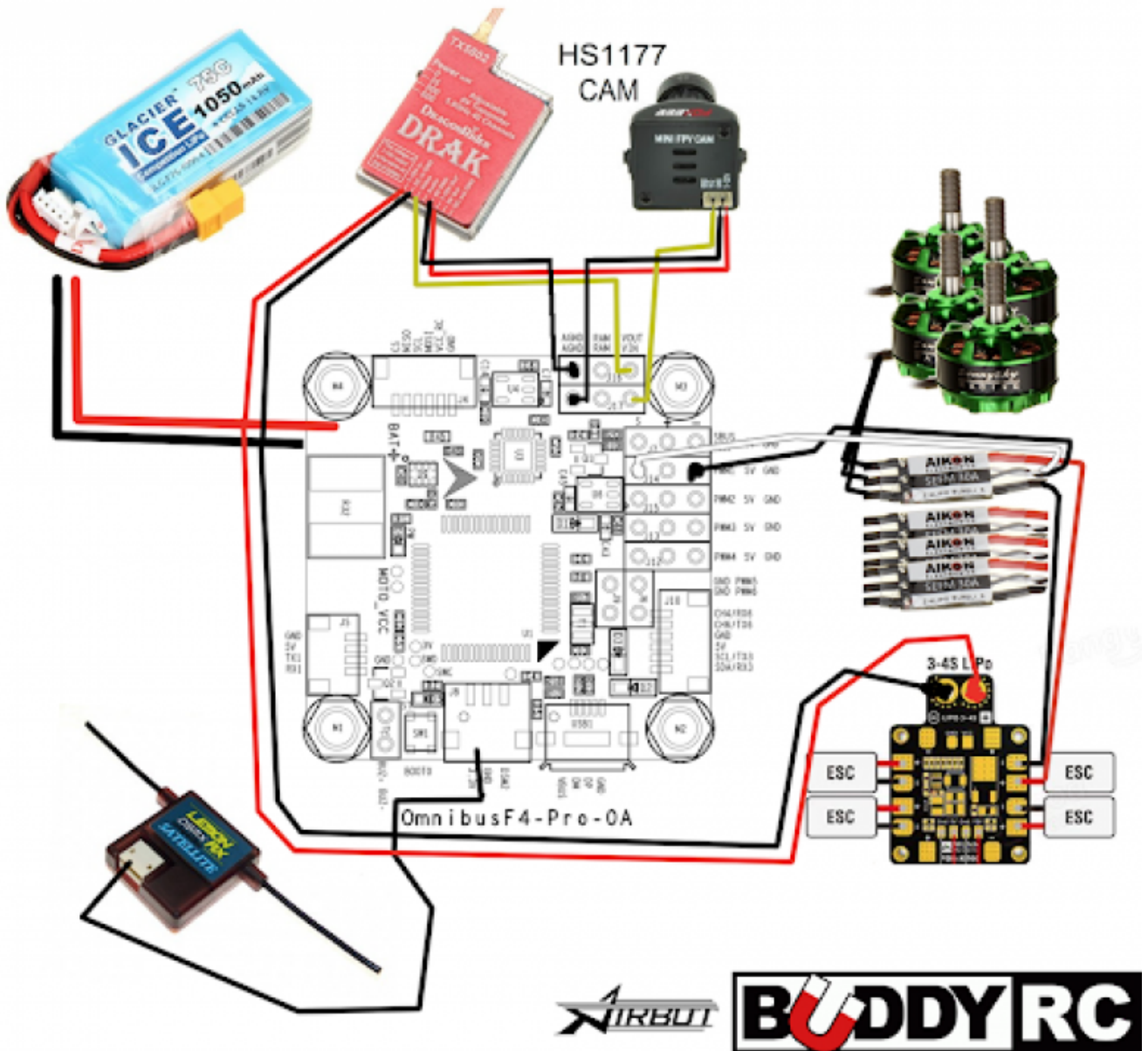

Product Gallery

OmnibusF4 Pro

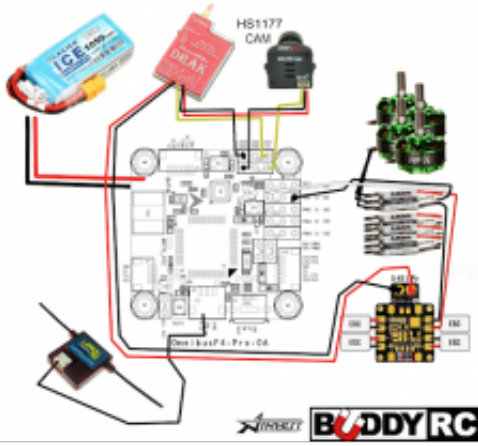

BUDDYRC

Omnibus F4 Pro Crossfire With Telemetry Unfyi Pro HV w/ SmartAudio

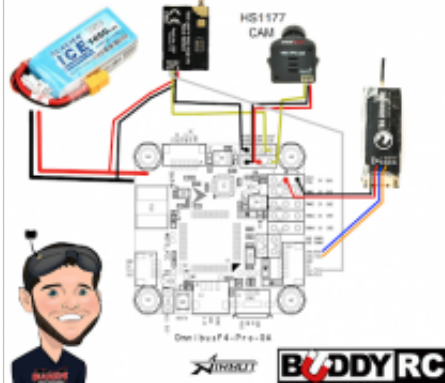

BUDDYRC



Readyt-sky

www.readyt-sky.com

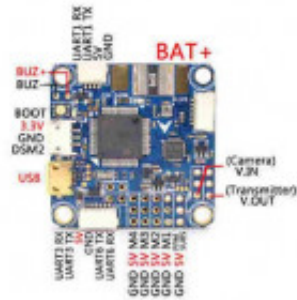

OMNIBUS F4 PRO V3 - ARDUPILOT WIRING

